

Technical manual



Translucent Building Element PC 2530-4

Made of polycarbonate for mullion free glazings

System PC 2530-4 AF 50 | PC 2530-4 AF 100

General Terms and Conditions

Stand: 10/10

1. Area of Applicability

1.1 Deliveries, services and offers by the supplier shall take place subject only to these general terms and conditions. They also apply for all future business relations even if they were not expressly agreed by the parties. Customer contradictory statements with regard to his own terms and conditions shall not be accepted. Deviations from these terms and conditions shall be effective only if the supplier has confirmed them in writing.

1.2. The acceptance of offers the supplier must be in writing. Orders shall be legally confirmed in writing by the supplier.

2. Offers and execution of Contract

2.1 Unless otherwise agreed in writing, general offers by the supplier are made without obligation. The offers made by supplier are valid for 30 days unless otherwise agreed.

3. Prices

3.1 All prices are net prices without VAT payable by the customer in addition to the statutory tax rate. The prices are ex warehouse of the supplier.

3.2 The supplier has the right to raise the prices reasonably if the period of time between entering into an agreement and the delivery was at least four months or if after the conclusion of the contract there was an increase in the cost price for raw materials, other materials and supplies, in wages and salaries and other costs to be borne by the supplier. The customer has to take over all new or increased taxes, customs duties, fees and other charges which are caused by legal or official measures and directly or indirectly relate to the deliveries and services rendered by the supplier to the customer.

3.3 The customer has the right to withdraw from the contract if the prices of the supplier increase by more than 10% in accordance with clause 3.2 above. The customer has the same right of withdrawal if the contract provides for partial deliveries and the prices for such partial deliveries increase by more than 10% within any respective one year period after the conclusion of the contract.

4. Delivery

4.1 Delivery dates or delivery times can be fixed on a binding nor non-binding basis and have to be agreed in writing. The agreed time of delivery begins with the dispatch of the confirmation of the order, however, not before the supplier has been furnished with the necessary documents, authorizations, securities and releases to be produced by the customer and not before an agreed deposit has been paid in time. If a fixed delivery time has been agreed, it will be extended by an appropriate period of time, should the customer fail to punctually provide all the supporting material he is obliged to procure as well as the agreed deposit.

4.2 Even if binding dates and times have been agreed, the supplier is not liable for delays in delivery and services which have been caused by force majeure or events which make it considerably more difficult or impossible for the supplier to deliver his goods or services unless the supplier's liability is caused by intention or gross negligence. Said delays entitle the supplier to postpone the delivery or service for the time of the hindrance plus a reasonable period to restore operations or to withdraw from the contract partially or entirely with regard to that part of the contract which has not yet been fulfilled. The supplier shall inform the customer without delay about his inability to fulfil his contractual obligation and shall pay back to the customer any payments that he has already made in fulfillment of the contract.

4.3 If the delay caused by the above-mentioned circumstances lasts for more than 3 months the customer has the right, after a reasonable period of grace for the supplier, to withdraw from that part of the contract which has not yet been fulfilled. In the event of delayed delivery/partial delivery or if the supplier is released from his obligation the customer shall not be entitled to claim any compensation. The supplier can only use the reference to the special circumstances for his delay if he has informed the customer immediately.

4.4 If the supplier is responsible for not observing dates and times with a binding commitment or if he is in default the customer is entitled to demand a compensation for default of 0,5% for each completed week of default but in total not exceeding a maximum of 5% of the invoiced value of the delivery and services which are subject of the delay. Other claims for compensation or damages are excluded unless the delay has been caused by at least gross negligence of the supplier.

4.5 The supplier has the right at any time to perform partial deliveries and services.

4.6 If a contractual product is ready for shipment and the delivery is postponed for more than one month at the customer's request or the shipment or taking delivery is delayed for reasons for which the customer is responsible, then the supplier is entitled to invoice the customer for warehousing costs to the amount of 2% of the invoice amount for the corresponding product from the first day of each following month. An extended liability pursuant to § 287 BGB is excluded.

5. Transport

Unless otherwise agreed, the shipment will be made at the expense of the customer who, at the request of the supplier, will directly pay for the transport costs or pay in advance. Forwarding instructions of the customer shall only be binding for the supplier if the supplier has given a confirmation in writing. The supplier has the right but not the obligation to insure the goods at the expense of the customer and to debit him with the corresponding costs. In the absence of a special instruction from the customer the supplier shall select the most convenient transport route at his due discretion.

6. Passing of the Risk

The risk passes to the customer at the time the consignment has been handed over to the forwarding agent or other consignor or has left the delivering works or warehouse. If the delivery becomes impossible through no fault of the supplier, the risk passes to the customer at the time the supplier notifies the customer that the consignment is ready for dispatch.

7. Liability for Defects

7.1 The warranty period is one year beginning with the receipt of the consignment at the place of destination. After one year claims of the customer based on defects of the delivered goods expire by limitation unless the law contains mandatory provisions for longer time limits, in particular for goods that were used in accordance with their normal purpose for a building structure and which is responsible for its defective nature. Industry-standard deviations in quality, weight, colour, width, thickness and unit length do not qualify for a claim. Only the product description of the supplier is deemed to be an agreed condition of the goods. Public statements, recommendations or advertisements of the suppliers do not represent a contractual condition of the product.

7.2 At its option without charge the supplier will repair or replace the contract products or their parts, which became fully or considerably unusable during the warranty period resulting from circumstance existing before the passing of risk. The customer is obliged to inform the supplier in writing immediately and in any case not later than one week after delivery about the discovery of such defects. Defects that can not be discovered even after a careful examination within this period will be notified to the supplier in writing immediately upon discovery.

7.3. Several subsequent improvements are allowed. If the supplier fails to improve after a reasonable term the customer shall become entitled at his opinion to demand either a reduction of the purchase price or rescission of the contract. In a minor breach of contract, especially with only minor defects, the customer has no right of rescission.

7.4. The customer is explicitly pointed out that the guarantee includes only correction of any defects present at the time of transfer of risk. In particular this means that liability is excluded for normal deterioration.

7.5. Any guarantee is void if the installation standards of the supplier have been ignored by the customer during installation of the contract products or were not kept during their use; if the technical information of the supplier has not been followed; if the customer makes changes to the contract products not being subject to prior consent of the supplier; and if the customer connects the contract products to other products not delivered by the supplier and without his prior written permission.

7.6. The foregoing provisions contain the complete guarantee for the contract products and exclude other warranty claims of any kind. Demands of customers to the suppliers from any here granted guarantee remain unaffected.

7.7. Services not covered by the scope of the warranty will be charged at our hourly rates (currently 100 EUR/h) and 0,55 EUR per kilometre calculated exclusive of VAT. This applies to futile travels despite the appointment if the claimant is not present or if the defect is not subject to our warranty.

8. Reservation of Title

8.1 Until all outstanding claims against the customer arising from the business relation have been fully satisfied, including all outstanding amounts on current account, interest, costs and cheques not yet fully cleared, which the supplier or one of his affiliated companies is entitled to, now or in the future, for whatever legal reason, the customer shall provide the supplier with the securities listed hereafter in this paragraph. The supplier will, at his discretion, release the securities given to him at the request of the customer so far as their realisable value exceeds the total claim of the supplier by more than 15%.

8.2 The consignment shall remain the property of the supplier. The supplier is entitled to claim reservation of title by simple declaration. Reservation of title shall also extend to resold goods and products resulting from processing. In the event of the goods being combined or mixed with material that does not belong to the supplier, the supplier shall always acquire coownership of the manufactured new items in the ratio of the value of the reserved-title product (invoiced value) to the value of the new item. In this case the customer is deemed to be unpaid custodian for the supplier.

8.3 For the time of the reservation of title the customer is not entitled to sell the contract products.

8.4 Notwithstanding the above customers who do not use the goods themselves but resell them for commercial purposes shall be revocably entitled to sell the goods in the normal course of business as long as they are not in default. The customer herewith fully assigns to the supplier who accepts the assignment, all accounts receivable (including any balance due on an account) and ancillary rights relating to the goods with the retention of title that accrue to the customer out of the resale of the delivered goods or through other rights (insurance, tort etc.). The customer shall be revocably empowered to collect, in his name but for the account of the supplier, all receivables arising out of the resales and assigned to the supplier. The power of collection and the right to process the goods shall expire in the event that the customer ceases to make due payments or suspends all payments.

8.5 Any dispositions or security transfers are in each case not allowed. The supplier has to be notified immediately if there is an attachment by third parties - also after mixture or processing of goods - and any other violation of rights concerning the goods belonging to the supplier under the reservation of title. The customer shall notify the third parties of the ownership of the supplier. The customer has to bear any costs and damages which may accrue in this context.

8.6 If the customer is in default with his payments or if he violates any obligation, the supplier is entitled to take back the goods covered by the reservation of title, to the customer's expense. The withdrawal and the bailment of the contract products do not constitute - unless the Installment law applies - an avoidance of contract.

8.7 In case the reservation of title is invalid according to the rules and regulations of the country where the goods are located or used, it is agreed that the supplier shall be given a sufficient security as an adequate financial equivalent for the invalid reservation of title. If the customer has to participate in providing the security, he has to undertake all measures at his own cost which the supplier requires of him.

9. Payment

9.1 Unless otherwise agreed in writing, the invoice amounts shall be payable within 10 days from the date of the invoice less 2% (cash) discount and within 30 days net cash without any discount. Day of payment shall be deemed the day the money is at the supplier's free disposal.

9.2 We accept your order under the express reservation that the volume of orders, considering all for our benefit open invoice amounts, will not exceed the credit limit granted to you by our credit insurance.

9.3 The supplier reserves the right to refuse cheques or bills of exchange for payment. Any acceptance is subject to the clearance of the said cheques or bills of exchange. The customer shall bear any additional costs incurred by the supplier arising from the acceptance of cheques or bills of exchange. The supplier has the right to appropriate payments of the customer first to any of his previous debts even if the customer's instructions run contrary. If costs and interest have already arisen the supplier may credit payments by the customer first against the costs, then against the interest and finally against the main obligation owed by the customer. Staff members and representatives of the supplier have the right to receive payments, also in the form of bills of exchange or cheques, only if they have a written authorization of the supplier.

9.4 In the event that the customer is in default in payment, the supplier shall be entitled to claim interest from the date of default at a rate which commercial banks charge for open current account borrowing rates but not less than 8% p.a. over the relevant base interest rate of the European Central Bank.

9.5 If the customer fails to comply with his financial obligation towards the supplier or one of his affiliated companies, especially if he does not clear a check or a bill of exchange, suspends payments or if the supplier learns about other circumstances which call into question the creditworthiness of the customer, the supplier is then entitled to declare the unpaid balance of principal to be immediately due and repayable even if cheques had been accepted. In such a case the supplier is also entitled to ask for advance payment or provision of security.

9.6 The customer is only entitled to offset against, to retain or to reduce the purchase price, even if he gives a notice of defects or puts forward counterclaims, if these counterclaims have been declared final and binding by court decision or are noncontroversial.

10. Limitation of Liability

Claims for damages for breach of obligations under the contract or tort are excluded against both the supplier and its vicarious agents, unless being subject to intentional or grossly negligent actions. The liability of the supplier is limited in any case to the average, foreseeable, typical and direct damages. The above limitations do not affect claims of the customer from product liability. Further, the liability limitations do not apply to body or health or life loss of the customer.

11. Other Provisions

11.1 All legal relations of parties are subject to the laws of the Federal Republic of Germany.

11.2 The place of jurisdiction for all disputes directly arising in connection with the business relation between the supplier and the customer shall exclusively be Mülheim an der Ruhr provided the customer is a merchant possessing full commercial capacity, a legal person under public law or a special fund under public law. In addition to this the supplier is entitled to file an action at the customer's competent law courts.

11.3 Should one or more of the above provisions be or become invalid or unworkable, it shall not affect the remaining provisions. The invalid or unworkable provision shall rather be replaced by a valid and workable one which comes closest to the purpose intended by the invalid provision.

11.4 The customer is not entitled to assign to third parties his rights and obligations arising from contractual relationships with the supplier without the supplier's express written consent.

11.5 Changes or additions to these terms or any other contractual agreements between the parties are to be made in writing. The same applies to agreements by which this procedural requirement should be abolished or relieved.

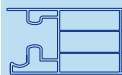

Contents

Stand: 10/10

General Terms and conditions

Contents

Product Range

General information on translucent building elements of polycarbonate

Technical information panel 1.4.1.1 to 1.4.1.2

Technical information on fixing and spans 1.4.2.0

Technical information non-thermally broken frame system Series 4050

Soffit Installation 1.4.6.1 to 1.4.6.2, Curtain wall installation 1.4.7.1 to 1.4.7.2

Side frame profiles 1.4.9.3

Technical information on windowsill systems for non-thermally broken base profiles 1.4.10.1 to 1.4.10.8

10 year warranty statements longlife and longlife plus

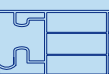

Product Range

Translucent Building Elements

Standard Series | Recommended installation combinations for frame profiles

Stand: 10/10



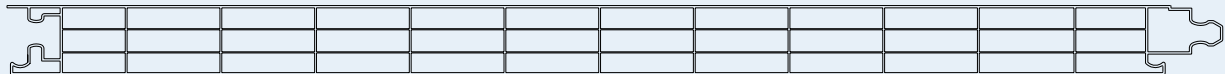

Standard - crystal and opal antiblind

PC 2530-4

Up-Value 1.40 - 1.70 W/m²K**



Building width 500 mm + 1 /- 1 %

Article no.	Image	Soffit assembly			Curtain wall assembly			assembly as an inclined surface (min. 15 degrees)		
		Top Profile	Side Profile	Base Profile	Top Profile	Side Profile	Base Profile	Top Profile	Side Profile	Base Profile
Frame profiles Series 4230 - non-thermally broken										
420040		X	X		X	X		X	X	
420080		X	X		X	X		X	X	
420031				X			X			
combinable with windowsills of 50 to 300 mm; while using windowsills adapter profiles may be necessary.										

** The Up-values depend on the installation situation, for further details please check our technical manuals and the physical properthes values.

Further technical information you can find in the single product data sheets.

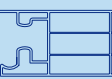

General information

on Translucent Building Elements of polycarbonate

Stand: 10/10

The raw material

Polycarbonate (PC) is a crystal clear, high impact thermoplastic.

Advantages

- Temperature resistance between -40 to +115°C, temporarily up to +130 °C
- High impact resistance nearly unchanging within these temperatures
- Good long term performance through UV protection

UV co-extrusion

With this technique a high concentrated UV protection film is homogenously melted onto the basis material while production process.

This offers the following advantages:

- No adhesion problems of UV protection film
- Same temperature behaviour of base and UV material
- No impairment of high impact (like e.g. with coated or painted surfaces)
- Makes small cold bending radiuses possible. Better resistance against environmental influences and ageing.

Outside Performance

Through the coextruded UV-protection film – which is always applied on the outer wall and if desired (surcharge). For some of the products is also available both-sided – our products offer best weather resistance and very good. Long term performance.

Warranty

Rodeca offers 10 years warranty (according to written warranty) to its uv-coextruded products regarding to yellowing **index – ageing – hail**

Light transmission

Customized on project demand RODECA can produce products with light transmission from almost 0% up to 80% light transmission (depending on material thickness and number of chambers).

Due to in-house compounding and raw material refinement special requests and colours can be realized. Please inquiry the project demands which vary from our standards.

G-Value (Solar gain value)

The G-values are related to light transmission and U-value. G-values can differ from product specification to product Specification from 0.68 down to 0.25!

Up-values and Uf-values (heat transmission coefficient - **Up=U-value panel; Uf =U-value frame**)

Throughout the multi-walled design of our translucent building elements in connection with joint tightness, translucent.

Facades with thermally broken aluminium profiles can be designed according to the newest requirements on Heat Insulation Ordinance.

UV transmission

UV-radiation is stopped almost to 100% up to 380 Nm because of high UV-stabilization with coextruded UV-protection. The remaining transmission in the area of UV radiation is less than 1%. This can be very important for UV sensitive goods.

IR-radiation transmission

Our panels with HEATBLOC-surface let through day light and reflect and stop at the same time selectively the heating radiation. The effect is cooler rooms through lower solar gain values.

Reflection of radar radiation

In the near of radar-units (e.g. at airports) it is important to have none or minimized influence through building elements. It is proven per certificate that RODECA products do not have influence on reflection and do not affect radar-units.

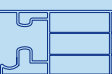

General information

on Translucent Building Elements of polycarbonate

Stand: 10/10

Service temperature

Minus 40 °C up to plus 115 °C (temporarily up to 130 °C). Please take into consideration service temperature especially with curtain facades respectively the use of dark foils for deposition of translucent building elements. Adequate distances and sufficient ventilation need to be considered in planning. (Danger of heat accumulation and associated deformations.)

Thermal properties

The high deformation resistance from shortly up to 130 °C is one of the advantages which RODECA products with coextruded surface offer. RODECA products can be used in spaces where other thermoplastic cannot be used anymore. Interesting to know is that white surfaces on roof applications can heat up to +100°C. (It is essential to respect thermal expansion/shrinking and to avoid heat accumulation.)

Colouring

The usual colours are:

- CLEAR with structure for panels for higher light transmission, light refraction.
Additionally the surface is less sensitive to scratches.
- OPAL-ANTIBLEND with light refractive and light transmitting pigments for an optimized diffused and antiglare light.
- COLOR Serie - transparent or semitransparent COLOURS, similar to RAL from approx. 300 m² on request
- BICOLOR Serie - two coloured finish, inner wall coloured, similar to RAL from approx. 150 m² on request
- DUOCOLOR - two coloured finish of translucent building elements custom made in transparent or semitransparent COLOURS similar to RAL from approx. 300 m² on request
- DECOCOLOR - two coloured finish, outer wall coloured, similar to RAL from approx. 150 m² on request

Qualities

Depending on application area and demand RODECA produces different qualities.

- LONGLIFE quality for one sided UV protection (Northern Europe (northwards the Alps)
(for UV radiation until max. 1400 Watt according to solar map)
- LONGLIFE PLUS quality for one sided UV protection
(for UV radiation > 1400 Watt according to solar map)
- Please inquire separately nonstandard warranties (SUPERLIFE)

Impact resistance/fracture behaviour

RODECA products made of PC are due to the raw material practically indestructible through beat, impact, stone throwing etc. Polycarbonate is 200 times more impact resistant than glass.

Polycarbonate building elements do not splinter, do not crumble and prevent risk injury through splinters.

They comply with German regulations on workplaces (Arbeitsstättenverordnung).

Hail storm

Currently doesn't exist a DIN standard, so our RODECA elements were tested at EMPA (Swiss testing laboratory) with a simulated hail test with a shot radius of 20 mm and no holes occurred. According to the current testing results we achieve the highest class (class 5) of the Swiss hail test with factory-new goods.

Ball rebound safety

Even an ice hockey puck hurled against the element at 130 km/h could not cause damage.

Unlimited ball rebound safety thus applies according to DIN 18032 T 3.

Fire resistance

PC has a very high ignition temperature of approx. 450 °C and in case of fire the smoke development is very little.

Depending on element thickness and material composition RODECA products are according to DIN 4102

B 1 of low inflammability or B2 normally inflammable. Additionally the products are classified according to European fire test DIN EN 13501 and classified according to different national tests. Please inquire the test certificates in case of need.

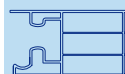

General information

on Translucent Building Elements of polycarbonate

Stand: 10/10

Meltable area according to DIN 18234

In many cases RODECA elements are used as melt-surface because their softening point is below 300°C.

Sound insulation

Polycarbonate elements have despite the light weight a good sound insulation value up to 27 dB according to DIN EN ISO 140-3 in testing facility. With a double wall construction a value of up to 43 dB is achievable. This value means the value that the panel achieves, due to constructive conditions this value may differ.

Chemical resistance

PC elements possess a very high resistance to chemicals but can be affected through some chemical bounds. Particulars about chemical resistance of PC elements you can check on compatibility list. Please inquire this list if needed.

Painting

In case that the Polycarbonate Elements for advertising reasons or similar will be painted or screen printed the compatibility of the painting system needs necessarily be tested before use. The aluminium frame profiles can be powder coated according to the project needs. Additionally RODECA offers the possibility to deliver TPE gaskets in custom made colours.

Vinyl wrap

For advertising purposes large scale letters can be glued onto the panels' surface. It is important that the foil and the glue don't contain substances which harm and affect polycarbonate.

Please clarify before usage the compatibility with the vinyl wrap supplier or the advertising company.

Cleaning

Water with a small percentage of neutral cleaning agents. No use of glass cleaner, rubbing agents or sharp edged subjects. No alkaline or tensile agents to be used.

Storage/Transport

RODECA elements made of Polycarbonate have to be protected before sun and wet conditions before installation and must be stored on a plain underground. In case of non-observance stock damages may occur. The stacking height of translucent building elements shouldn't exceed 200 cm .

Packaging

The Translucent Building Elements are delivered with protective foil. The delivery is carried out - depending on length - from one to four pieces for hand unloading in a recyclable plastic wrapping or on pallet (for forklift unloading). Please unpack briefly before installation to avoid contamination in the hollow chambers.

The protective film can be removed after processing and installation.

Processing

The Polycarbonate Elements can be smoothly cut with common tools, e.g. pad saw (saw blade with fine indentation) Incidental shavings are to be removed with oil free and water free compressed air. Drill holes (preferably steel-, twist drill or wedge angle drill) need to be at least 40 mm away from elements side and always minimum 50% larger than the screw radius (because of expansion and shrinking due to temperature).

Expansion/Shrinking

The expansion coefficient for Polycarbonate is 0,065 mm per °C and per m and hence three times as high as the expansion coefficient of aluminium.

Rule of thumb: 3mm per m for 50 °C difference in temperature. Due to temperature differences the length and width of the panel change. The changes in length of the panel need to be considered constructional. RODECA has considered the lengths expansion in its system accessories.

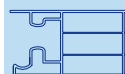

General information

on Translucent Building Elements of polycarbonate

Stand: 10/10

Sealing

Sealings and sealing tape need to be Polycarbonate compatible and approved for usage from respective producer otherwise damages on the elements are possible.

Silicone: Must be absolutely neutral and solvent free, f. e. RODECA PC-Silicone 2001. The aluminium profiles need to be protected (according to state of the art of the technique) against galvanic corrosion and an adequate sealing of building has to be done.

Condensation

Polycarbonate is a material that is permeable for vapour diffusion so that condensation may occur. This is not a flaw in quality. Depending from weather/climate this appearance is of temporary nature which is direct linked to temperature and humidity. Condensation doesn't effect the quality of the panels. (Double sided sealing reduces the appearance of condensation in the hollow chambers. (Expertise of the institute Fraunhofer)).

Formation of algae

Algae can just occur in connection of dirt and humidity. Taping of the polycarbonate panels prevents appearance of dirt while stocking and transport.

Sealing of head ends

The head ends of the panels must be closed before installation - directly after unpacking - with suitable sealing to avoid dust and dirt.

With a sealing that is permeable for vapour diffusion (or permeable to water) you run risk that dust, diesel exhaust particulates, gases or other fine particles can diffuse into the panel chambers. For projects with increased particulate matter emission respectively environmental pollution are additionally precautions to be taken. With a silicone joint sealing and additional sealing methods the optical properties of the translucent building materials can be maintained. Every element needs to be sealed singularly.

Safety

The regional building regulations as well as the general safety regulations for non supporting wall and roof coverings are effective. For a penetration (according to workplace ordinance (German „Arbeitsstättenrichtlinie“) it is mandatory to use a board of 50 cm width.

Tolerances

Panels

Length -0 to 15 mm (depending on length)

Thickness $\pm 1 \%$

Width $\pm 1 \%$

Flection vertical in running direction $\pm 0,5 \%$ of length

All tolerances based on room temperature of 20 °C

Disposal of waste/Environmental protection

RODECA takes leftovers from cuts etc. back.

Packaging is fully recyclable.

Joint permeability

Especially for large facades it is important not only to achieve a good U-value but also a product which is tested on joint permeability and complies with the required DIN values. RODECA panels fulfil this demand with over 90 % and passed project wise blower door tests for the whole construction.

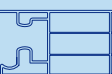

General information

on Translucent Building Elements of polycarbonate

Stand: 10/10

System accessories

For almost all installation situations RODECA supplies appropriate and well engineered accessories as well as Ventilation flaps or smoke and heat exhaust flaps in many different versions.

Certification/Quality standard

RODECA products are tested according to different criteria and are both external controlled (inspection mark) and internally controlled through laboratory and quality controls. Please note that translucent building elements are presumed to be unregulated building materials and are subject to the regulation of the rules of Building Elements A part 2.

The outcome of the requirement to the usability proof in combination with local regulation need to be considered by designer/installer. If RODECA forwards building certification for translucent building elements these regulations must be complied with. Due to the not finalized harmonization of National and European norms please check whether the certifications are suitable for the particular application purpose.

Miscellaneous

Data subject to technical change.

The aforesaid information and our application technological advice in words, written and through tries, are carried out to best of one's knowledge. This information is non-binding advice even in regards to property rights of third parties. Our advice does not release you from your responsibility. To proof self dependently our current advices - especially our safety data sheets and technical information - and to test if our products in regards to applicability for the intended system and use. Application, use and handling of our products – produced from you based on our application technological advice - take place out of our control and therefore you are solely responsible. The sale of our products is carried out at our current general sales and delivery conditions. Please check before handling if our products are applicable for the intended purpose.

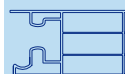

1.4.1.1/1

Translucent Building Elements

Product properties - physical properties

Stand: 10/10

Up-Value 1.40 to 1.70 W/m²K

Depending on horizontal or vertical installation situation as interior and exterior application according to DIN EN ISO 6946:2008 / DIN EN ISO 10077-2:2008

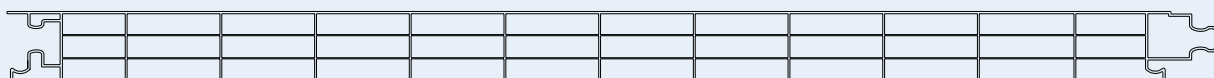

Flammability classifications:

PC 1530-4
PC 2530-4
PC 3530-4

fire class B1 according to DIN 4102
fire class B2 according to DIN 4102
fire class B, s 2 - d 0 DIN EN 13501

Building width:

500 mm +/- 1 %

Thickness:

30 mm +/- 1 %

Weight:

approx. 3.60 kg/m²

Number of layers:

4 layers / 3 chambers

Modulus of elasticity:

2,400 N/mm²

Coefficient of linear expansion:

0.065 mm/m/°C

UV admission:

0 % wavelength until 380 nm stopped almost a 100 %

Production tolerances:

Length: - 0/+ 15 mm (at room temperature)

Flection: +/- 0.5 %

Versions:

Standard:

Colour:



Colours: crystal, opal antiblind

Available in any solid colour similar to RAL.

The Color Version can be delivered with a minimum quantity of 300 m² without separate surcharges for colour change.

U-Values:

Isotherm- and temperature pattern from -10 °C outside and +20 °C inside at vertical assembly



Isotherms:

Red: 13 °C
Blue: 10 °C
Black: 0 °C

Installation situation interior:

Up-value 1.4 W/m²K vertical
Up-value 1.6 W/m²K horizontal

Installation situation exterior:

Up-value 1.6 W/m²K vertical
Up-value 1.7 W/m²K horizontal

Sound insulation:

approx. Rw 20 dB



1.4.1.1/2

Product properties

Physical properties

Stand: 10/10

Up-Value 1.40 to 1.70 W/m²K

Depending on horizontal or vertical installation situation as interior and exterior application according to DIN EN ISO 6946:2008 / DIN EN ISO 10077-2:2008

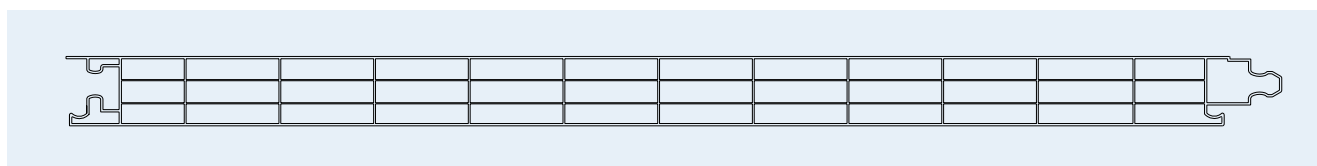

Transmission:

Standard:

Colour: crystal 67 %
 Colour: opal antiblind approx. 50 %

Colour:

Depending on the colour, for example approx. 53 % for glass green opalized (antiblind)

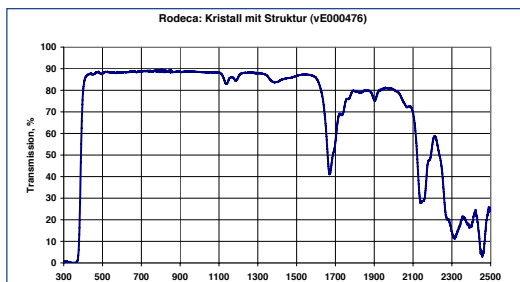

The Measurement of the transmission values was carried out with application of a natural day light lamp of 20,000 Lux in connection with a lux meter Lightmeter MS 1000-300 – measuring range 200 to 50,000 LUX) exemplarily on a 1 mm thick PC.

Solar gain values g

Standard:

Colour: crystal approx. 0.69
 Colour: opal antiblind approx. 0.58

Colour:

Depending on the colour for example Petrol (RAL 6027) approx. 0.56 %

(The g-values are interpolated and may vary depending on the angle of sun shine incidence on building surfaces.)

The aforesaid information and our application technological advice in words, written and through tries, are carried out to best of one's knowledge. This information is non-binding advice even in regards to property rights of third parties. Our advice does not release you from your responsibility. To proof self dependently our current advices - especially our safety data sheets and technical information - and to test if our products in regards to applicability for the intended system and use. Application, use and handling of our products – produced from you based on our application technological advice - take place out of our control and therefore you are solely responsible. The sale of our products is carried out at our current general sales and delivery conditions. Please check before handling if our products are applicable for the intended purpose.

1.4.2.0

Translucent Building Elements

System PC 2530-4 AF 50 | System PC 2530-4 AF100

Stand: 10/10

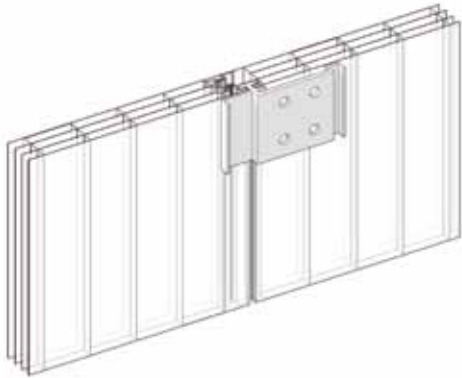

General

The RODECA flat fasteners are made of extruded aluminium profiles, afterwards cut, pierced and trovalized finished. We recommend fixing the flat aluminium fasteners with stainless steel screws and seal discs. The fixing materials need to be chosen in type and finish adequately to substructure. The maximum excess length of flat fasteners above the substructure may not exceed 5mm.

Art. No. 494040100

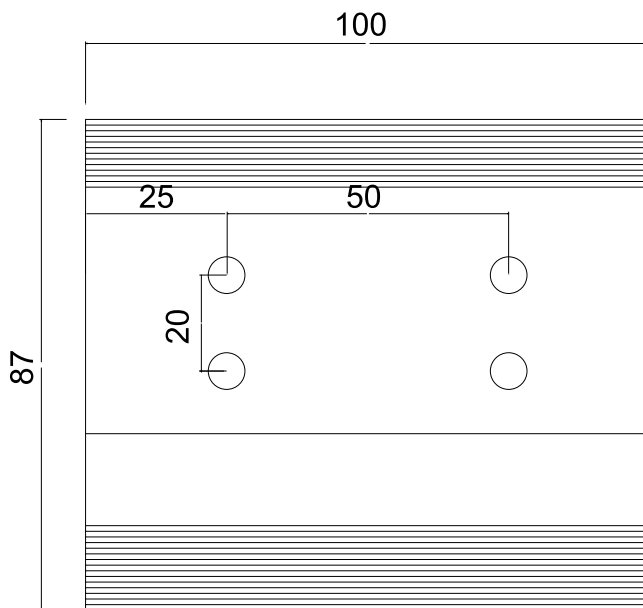

Art. No. 49404050

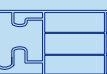
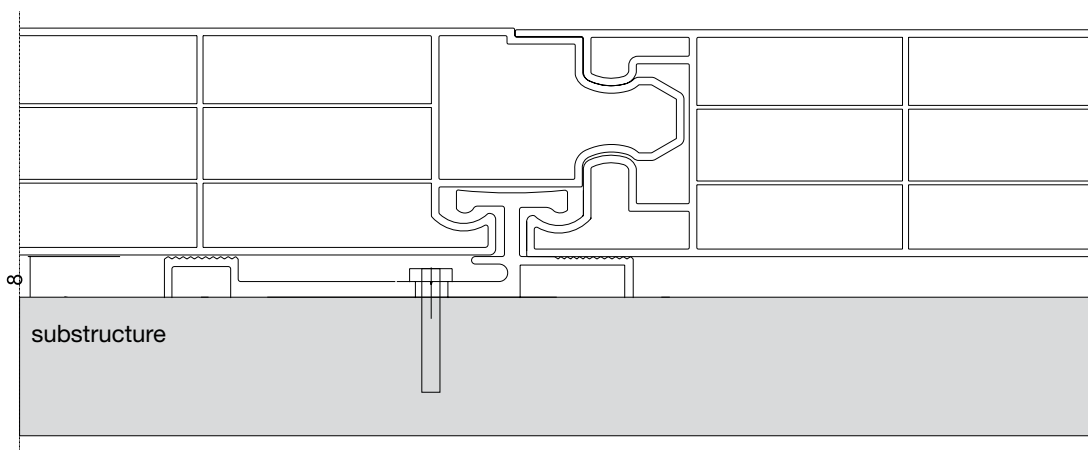
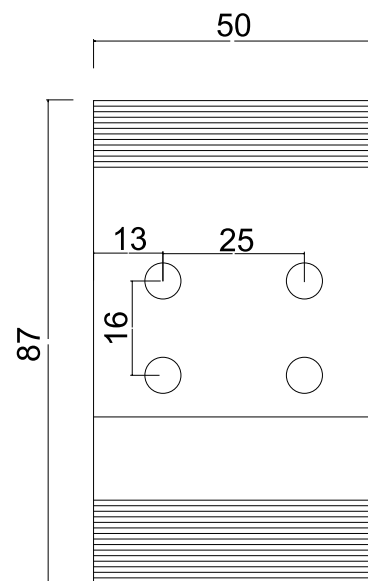

1.4.6.1

Translucent Building Elements

Series 4230 | Frame system non-thermally broken

Stand: 10/10

Soffit installation

Installation for panel lengths up to 6.0 m*
* at Central European temperature conditions

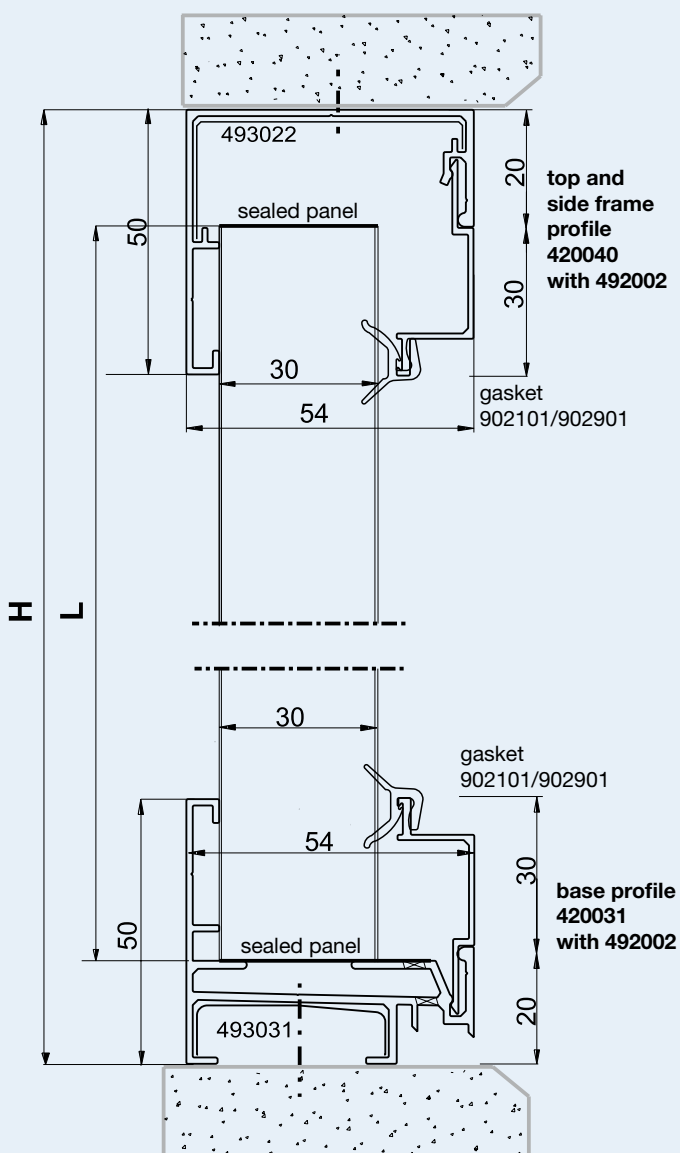

Calculation of the panel length:
L in mm = Height H in mm – 40 mm.

General

The frame system series 42 is made of extruded aluminium profiles consisting of aluminium EN AW-6060, status T 66 according to DIN EN 755-2. The gaskets are made of EPDM or TPE.

Initial length/units

Aluminium profile	6.00 m
Clamp-batten	3.0 m
EPDM-gasket, black	50 m rolls
Alternative: TPE gasket, grey or special	
Colour on request	50 m rolls
Profile connector	10 cm

Article numbers

420040 = Top frame profile
493022 = Profile connector for 420040

492002 = Profile connector for L = 3.0 m

420031 = Base profile
493031 = Profile connector for 420031

492002 = Clamp batten in L = 3.0 m

Versions

Aluminium - mill finish
Aluminium - anodized E6/EV1
Aluminium - plastic coated according to RAL

902101 / 902901 = outer plug gasket optional out of EPDM or TPE

Installation of the aluminium profiles with **stainless steel** screws and sealing disc. Dimensions and size according to substructure and extract values of fixing materials.

Please note:

The coefficient of linear expansion for
Aluminium profiles = 0.023 mm/m°C.
Polycarbonate panels = 0.065 mm/m°C.

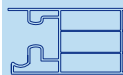

1.4.6.2

Translucent Building Elements

Series 4230 | Frame system non-thermally broken

Stand: 10/10

Soffit installation

Installation for panel lengths up to 12.0 m*
*at Central European temperature conditions

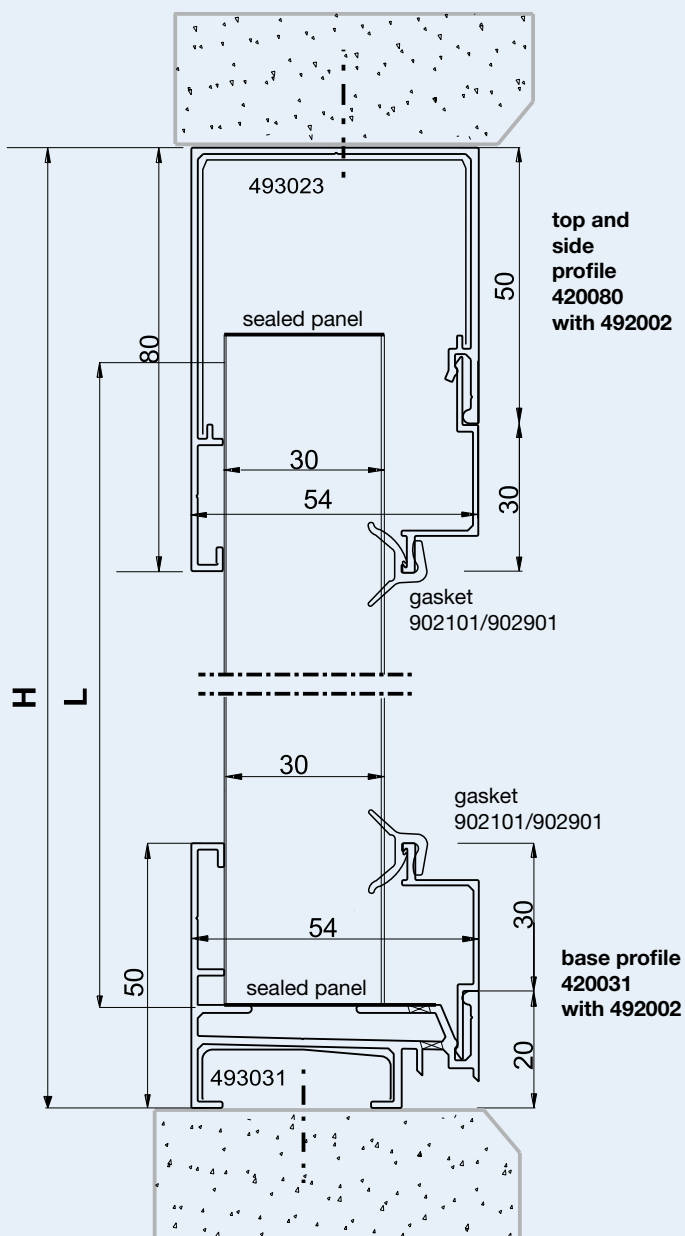

Calculation of the panel length:
L in mm = Height H in mm – 60 mm.

General

The frame system series 42 is made of extruded aluminium profiles consisting of aluminium EN AW-6060, status T 66 according to DIN EN 755-2. The gaskets are made of EPDM or TPE.

Initial length/units

Aluminium profile	6.00 m
Clamp batten	3.0 m
EPDM-gasket, black	50 m rolls
Alternative: TPE gasket, grey or	
Special colour on request	50 m rolls
Profile connector	10 cm

Article numbers

420080 = Top frame profile
493023 = Profile connector for 420080

492002 = Clamp batten in L = 3.0 m

420031 = Base profile
493031 = Profile connector for 420031

492002 = Clamp batten in L = 3.0 m

Versions

Aluminium - mill finish
Aluminium - anodized E6/EV1
Aluminium - plastic coated according to RAL

902101 / 902901 = outer plug gasket optional out of EPDM or TPE

Installation of the aluminium profiles with **stainless steel** screws and sealing disc. Dimensions and size according to substructure and extract values of fixing materials.

Please note:

The coefficient of linear expansion for
Aluminium profiles = 0.023 mm/m°C.
Polycarbonate panels = 0.065 mm/m°C.



1.4.7.1

Translucent Building Elements

Series 4230 | Frame system non-thermally broken

Stand: 10/10

Curtain wall installation

Installation for panel lengths up to 6.0 m*
* at Central European temperature conditions

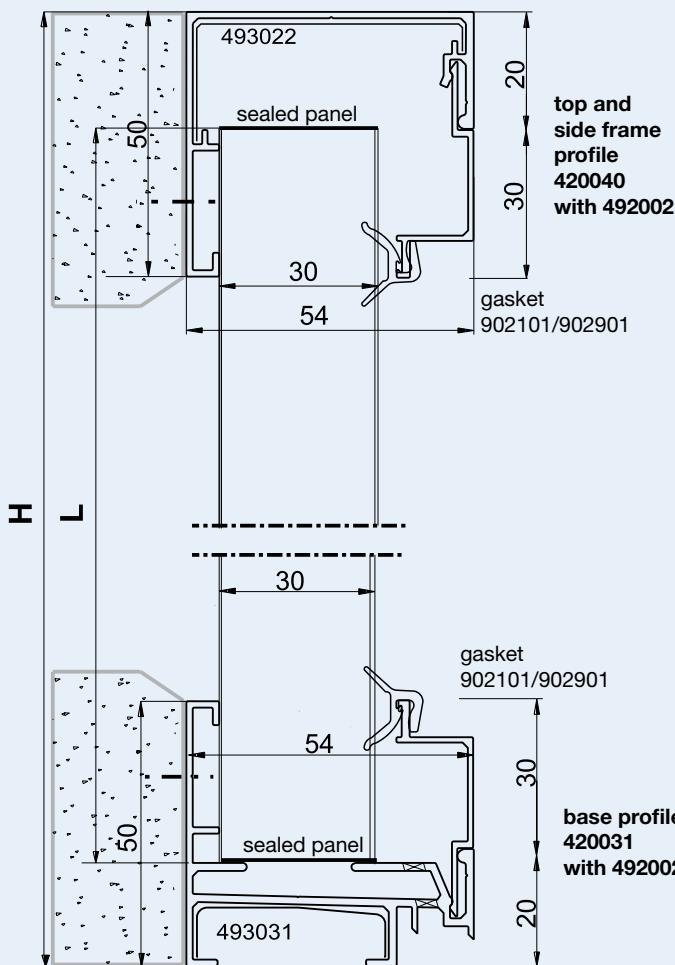

Calculation of the panel length: $L \text{ in mm} = \text{Height } H \text{ in mm} - 40 \text{ mm}$

General

The frame system series 42 is made of extruded aluminium profiles consisting of aluminium EN AW-6060, status T 66 according to DIN EN 755-2. The gaskets are made of EPDM or TPE.

Initial length/units

Aluminium profile	6.00 m
Clamp batten	3.0 m
EPDM-gasket, black	50 m rolls
Alternative: TPE gasket, grey or	
Special colour on request	50 m rolls
Profile connector	10 cm

Article numbers

420040 = Top frame profile
493022 = Profile connector for 420040

492002 = Clamp batten in L = 3.0 m

420031 = Base profile
493022 = Profile connector for 420031

492002 = Clamp batten in L = 3.0 m

Versions

Aluminium - mill finish
Aluminium - anodized E6/EV1
Aluminium - plastic coated according to RAL

902101 / 902901 = outer plug gasket optional out of EPDM or TPE

Installation of the aluminium profiles with **stainless steel** screws and sealing disc. Dimensions and size according to substructure and extract values of fixing materials.

Please note:

The coefficient of linear expansion for
Aluminium profiles = 0.023 mm/m°C.
Polycarbonate panels = 0.065 mm/m°C.

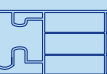

1.4.7.2

Translucent Building Elements

Series 4230 | Frame system non-thermally broken

Stand: 10/10

Curtain wall installation

Installation for panel lengths up to 12.0 m*
* at Central European temperature conditions

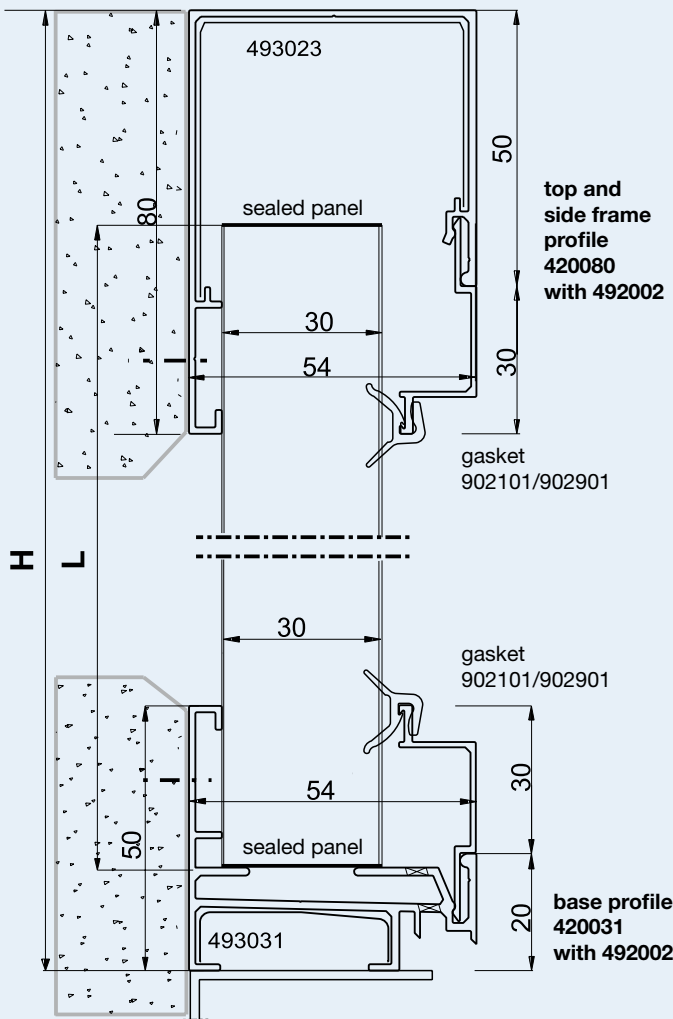

We recommend to support the base profile starting from 6.00m panel length

Calculation of the panel length:
L in mm = Height H in mm - 60 mm

General

The frame system series 42 is made of extruded aluminium profiles consisting of aluminium EN AW-6060, status T 66 according to DIN EN 755-2. The gaskets are made of EPDM or TPE.

Initial length/units

Aluminium profile	6.00 m
Clamp batten	3.0 m
EPDM-gasket, black	50 m rolls
Alternative: TPE gasket, grey or	
Special colour on request	50 m rolls
Profile connector	10 cm

Article numbers

420080 = Top frame profile
493023 = Profile connector for 420080

492002 = Clamp batten in L = 3.0 m

420031 = Base profile
493031 = Profile connector for 420031

492002 = Clamp batten in L = 3.0 m

Versions

Aluminium - mill finish
Aluminium - anodized E6/EV1
Aluminium - plastic coated according to RAL

902101 / 902901 = outer plug gasket optional out of EPDM or TPE

Installation of the aluminium profiles with **stainless steel** screws and sealing disc. Dimensions and size according to substructure and extract values of fixing materials.

Please note:

The coefficient of linear expansion for
Aluminium profiles = 0.023 mm/m°C.
Polycarbonate panels = 0.065 mm/m°C.

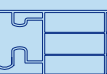

1.4.9.3

Translucent Building Elements

Series 4230 | Frame system non-thermally broken

Stand: 10/10

Side endings for soffit and Curtain wall installation

Top and side frame profile 420040 with 492002

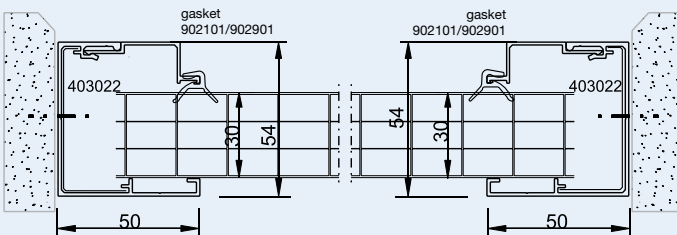

Top and side frame profile 420040 with 492002

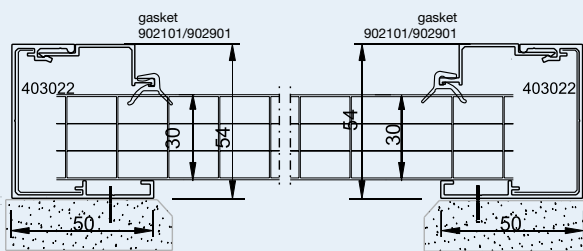

Top and side frame profile 420080 with 492002

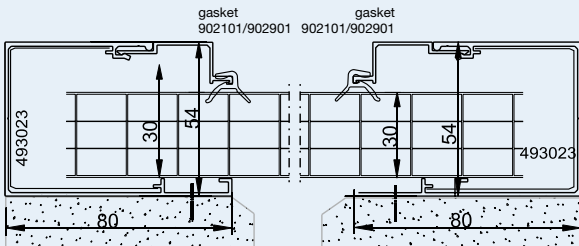

Top and side frame profile 420080 with 492002

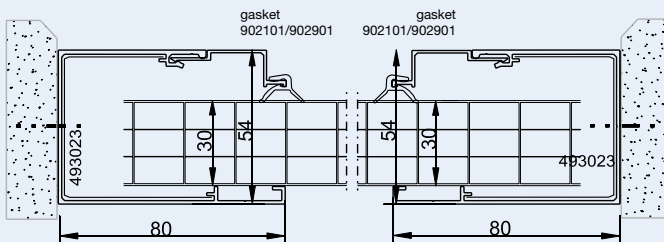

General

The frame system series 42 is made of extruded aluminium profiles consisting of aluminium EN AW-6060, status T 66 according to DIN EN 755-2. The gaskets are made of EPDM or TPE.

Initial length/units

Aluminium profile	6.00 m
Clamp batten	3.0 m
EPDM-gasket, black	50 m rolls
Alternative: TPE gasket, grey or	
Special colour on request	50 m rolls
Profile connector	10 cm

Article numbers

420040 = Side frame profile
493022 = Profile connector for 420040

492002 = Clamp batten in L = 3.0 m

420080 = Side frame profile
493023 = Profile connector for für 420080

492002 = Clamp batten in L = 3.0 m

Versions

Aluminium - mill finish
 Aluminium - anodized E6/EV1
 Aluminium - plastic coated according to RAL

902101 / 902901 = outer plug gasket optional out of EPDM or TPE

Installation of the aluminium profiles with **stainless steel** screws and sealing disc. Dimensions and size according to substructure and extract values of fixing materials.

Please note:

The coefficient of linear expansion for
 Aluminium profiles = 0.023 mm/m°C.
 Polycarbonate panels = 0.065 mm/m°C.

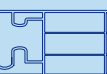

1.4.10.1

Translucent Building Elements

Series 4975 | Windowsills and Accessories

Stand: 10/10

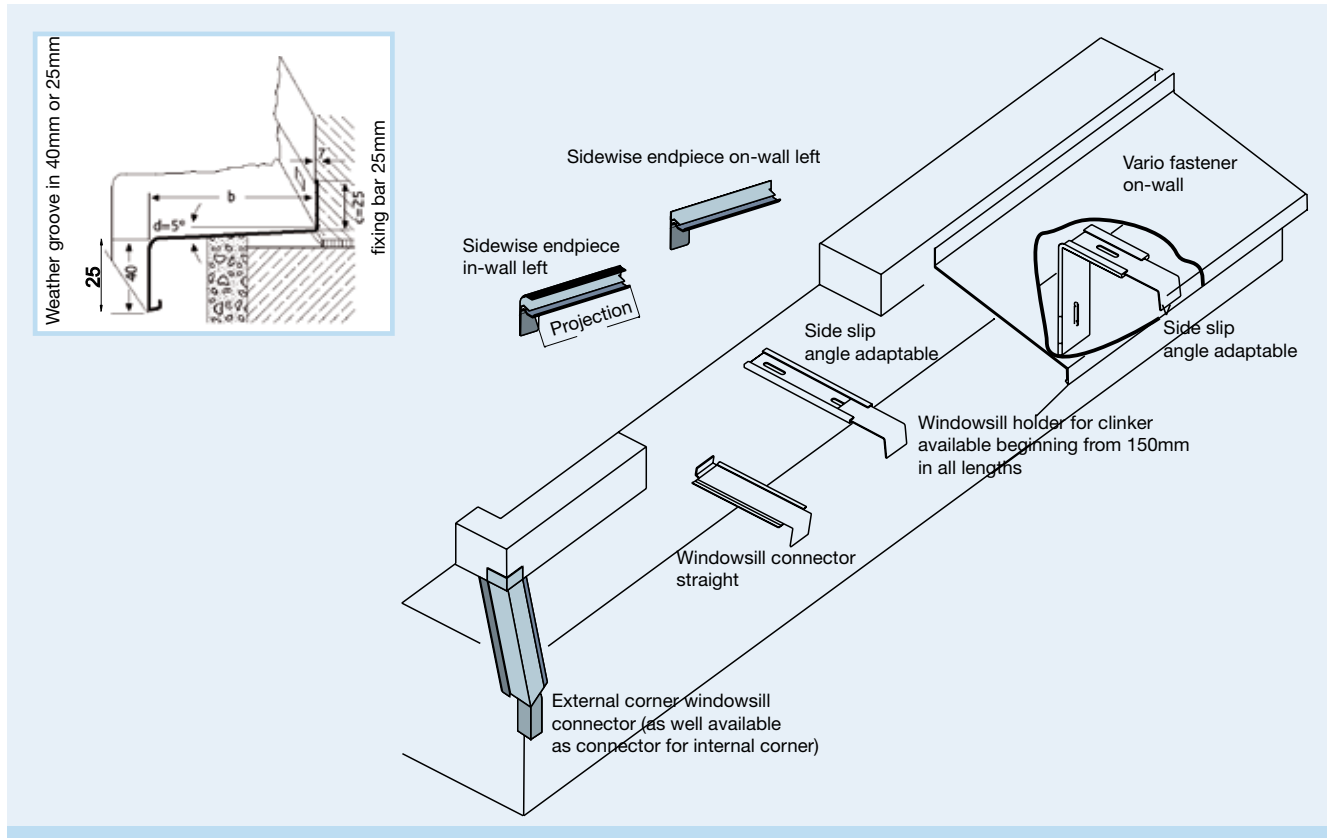

Installation manual - Windowsill products

Please note before installing:

- Thermal expansion of the profiles:
Windowsills over 3,000 mm long must be divided in the middle and extended through a connection joint. The windowsills must be sufficiently fastened to the frame and be tight against rain water. The possibility for the windowsill to expand must be made sure depending on length.
- For sound insulation during heavy rains we recommend to provide windowsills with a sound absorptive stripe. The sound absorptive area should make out about 1/3 of the windowsill area.
- For on-site fixing of windowsill on the profile (non-RODECA profile) of the windows the self-sealing gasket (black or white) is to be used.
- Aluminium windowsills should project about 40 mm above the finished facade. The profile width should be measured accordingly. This applies only for installations with side endings. Without side endings the projection of windowsills should not fall below 20 mm.
- From a projection/profile depth of 150 mm holders (Vario fastener or clinker fastener) are necessary to be used on the structure (every 800 to 1,000 mm).

Note for installation:

Before installation of the side elements stick the sound absorptive stripes approx. 50 mm behind the beginning of the drip edge on the bottom side of the windowsill profile.

Please don't forget to leave free approx. 30 mm on the front sides of the windowsill in order to be able to install the side elements.

On the predrilled (perforated) side of the windowsill insert the gasket, check the straight and precise seating of the rubber profile and remove the cover strip from the adhesive surface. (This does not apply to assemblies with RODECA profiles)

Before screwing the windowsills, if using Rodeca profiles, the base profile and chosen adapter (depending on the projection from zero up to two adapters can be used under the profiles) are installed to the supporting substructure. The side elements are to be clipped on in advance. After clipping on the side elements and fastening the windowsill, seal the connection points all around. Please leave at least 5 mm on each side of the windowsill for the thermal expansion.

If implementing full thermal protection it is important to make sure that the vario fastener is fixed before placing the insulation to the masonry. This also applies if using the holder for clinker installation.

The windowsill with the protective foil side at the top is to be fixed at the edge of the window using windowsill screws*. The foil may not be covered while assembling the connector elements. Make sure to provide the final windowsill slope of at least 5° after the assembly. When plastering the side elements please check the presence of expansion joint and keep in mind the thermal expansion of aluminium. Coarse mortar and plaster remnants must be removed immediately from the protective foil. After completion of the facade work in the windowsill area, the protective foil has to be removed as quickly as possible.

* Size of the screw head – 3.9 mm

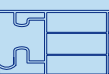

1.4.10.2

Translucent Building Elements

Series 4975 | Windowsills and Accessories

Stand: 10/10

Example for construction group:

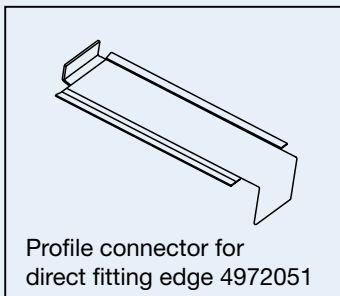
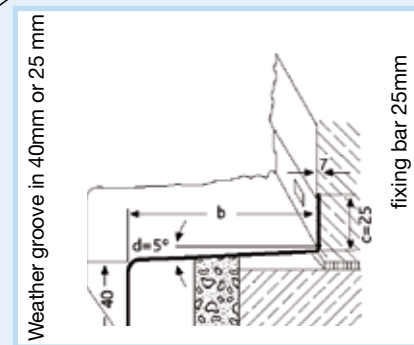
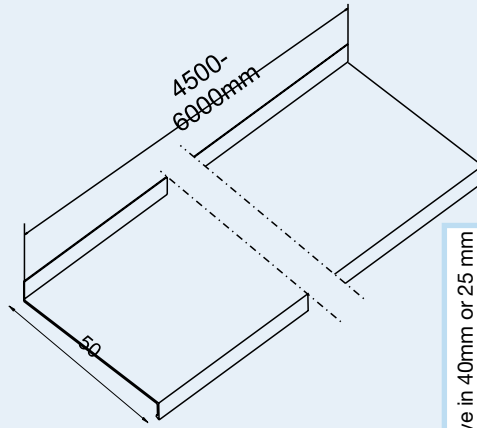
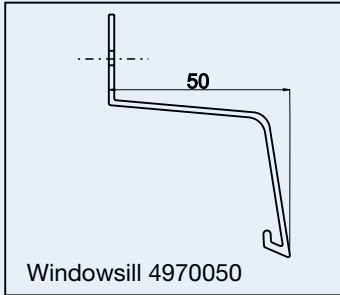

Windowsill projection

Example: article numbers for a 50 mm windowsill projection:

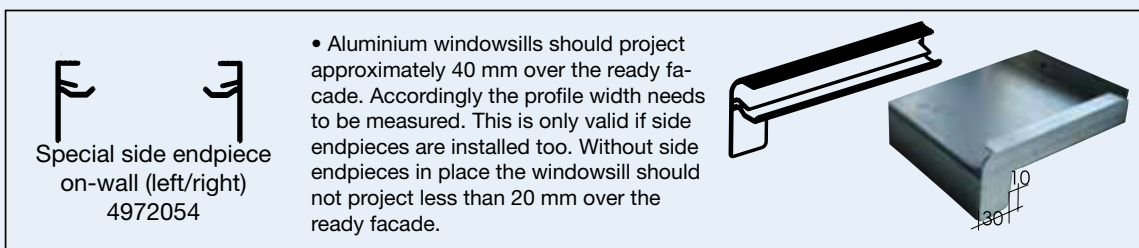
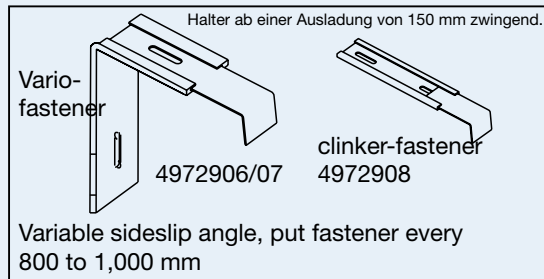
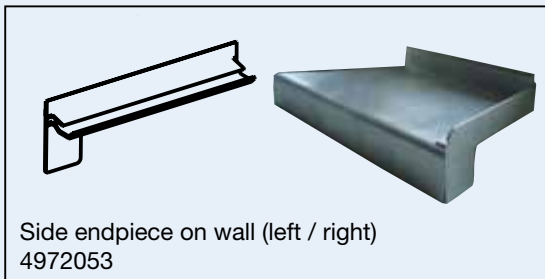
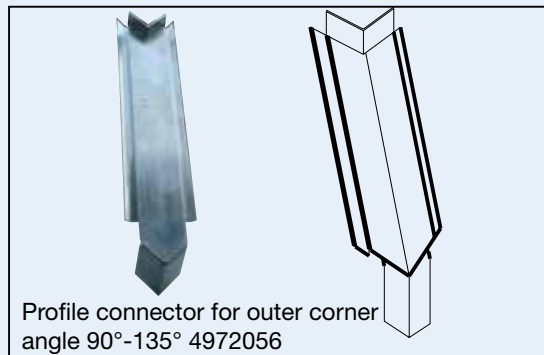
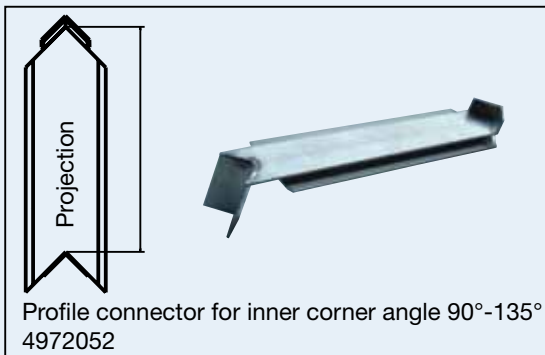

1.4.10.5

Translucent Building Elements

Series 4230 | Windowsills and Accessories

Stand: 10/10

Adaptable aluminium windowsills for RODECA base profiles
 420031 – Application with adapter profiles
 For additional information about the construction groups
 please see our price lists.

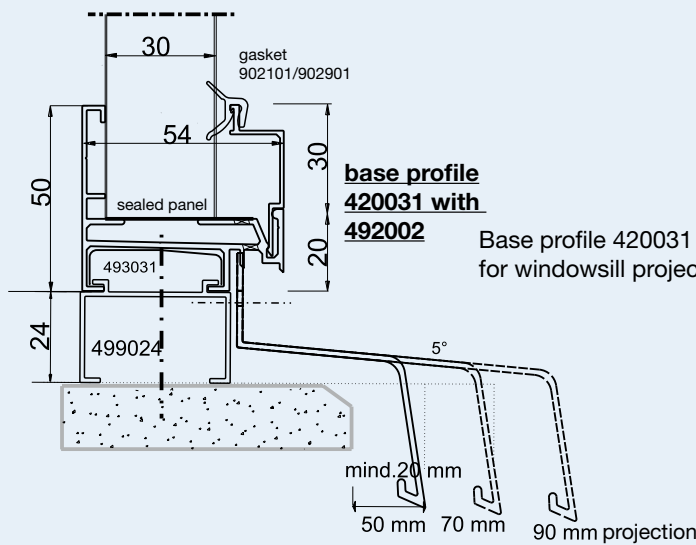
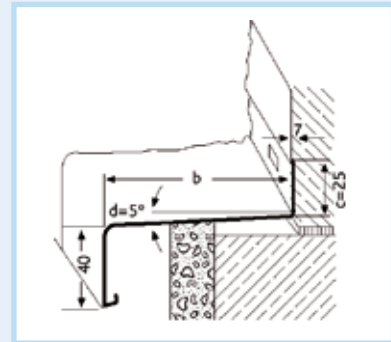

Aluminium windowsills should project approximately 40 mm over the ready façade.

Accordingly the profile width needs to be measured. This is only valid if side end pieces are installed as well. Without side end pieces in place the windowsill should not project less than 20 mm over the ready façade (refer to 1.2.10.2 below).

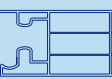
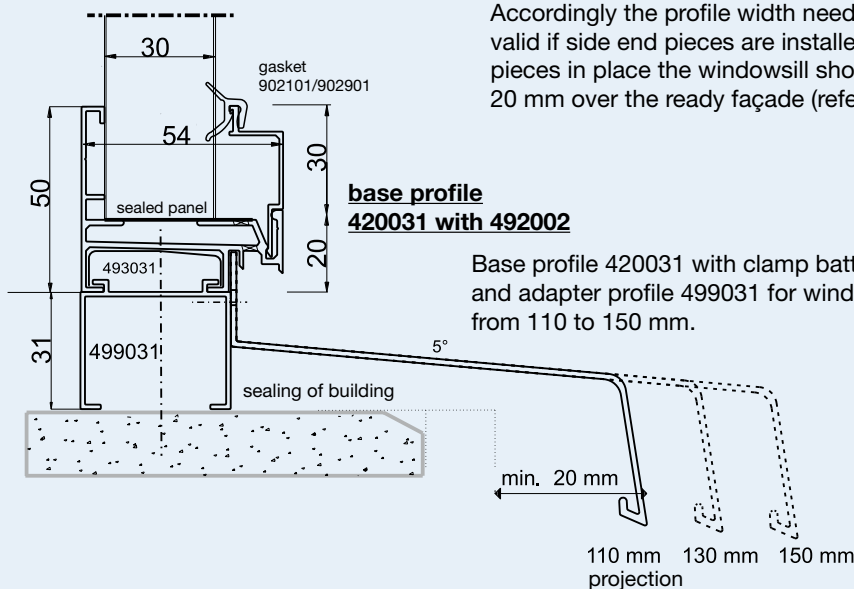

1.4.10.6

Translucent Building Elements

Series 4230 | Windowsills and Accessories

Stand: 10/10

Adaptable aluminium windowsills for RODECA base profiles 420031 – Application with adapter profiles
For additional information about the construction groups please see our price lists.

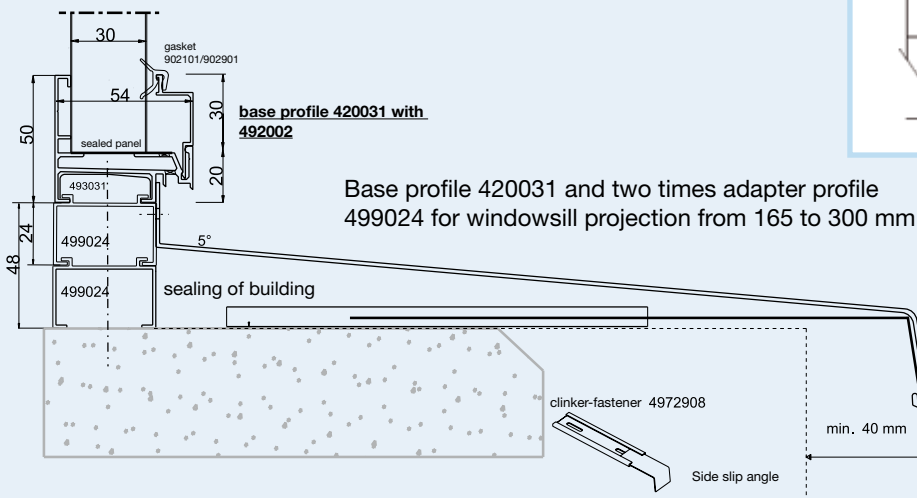
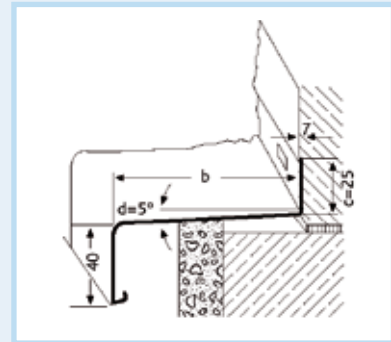

For projections/profile depth of more than 150 mm additional fasteners (Vario-fastener oder clinker-fastener) on the structure are needed (every 800 to 1,000 mm).
Aluminium windowsill should project approximately 40 mm over the ready facade. Accordingly the profile width needs to be measured. This is only valid if side end pieces are installed too.
Without side end pieces in place the windowsill should not project less than 20 mm over the ready facade (refer to 1.4.10.2. below).

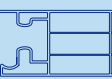
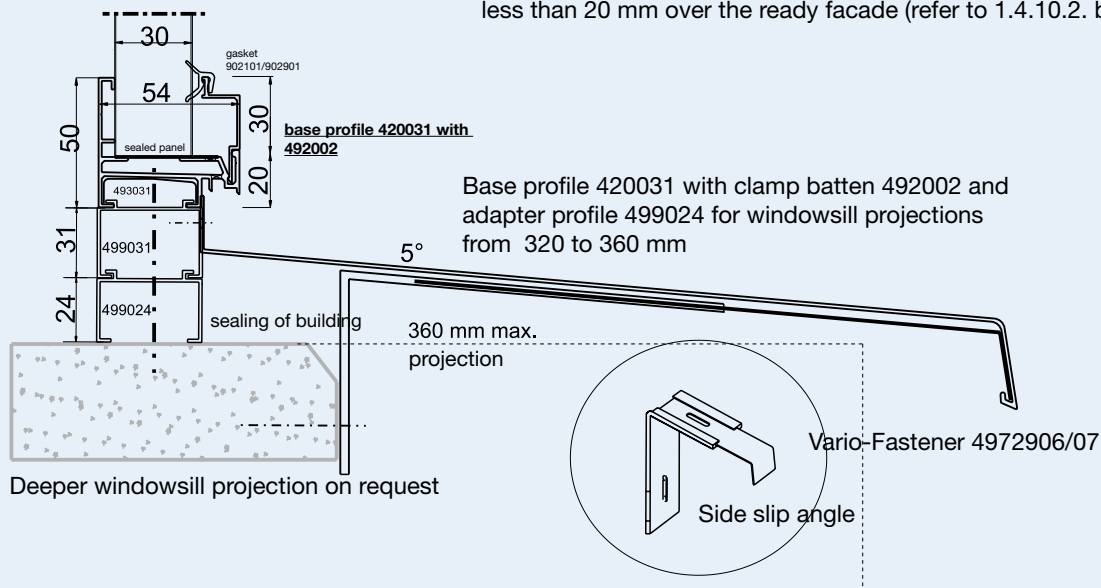

10- years warranty LBE / MFP / U-Panels longlife

Stand: 10/10

The limited warranty assumed by RODECA vis-à-vis the purchaser shall be in effect in addition to the statutory liability for defects of the seller which shall remain completely unaffected thereby.

1.0 Subject Matter of the Warranty

RODECA warrants to the purchaser that the panels manufactured by RODECA (LBE / MFP / U-Panels) of the type "longlife plus" and as from the thickness of 3 mm and as from 1.50 kg/m² (Subject Matter of the Warranty) shall possess the following properties during the warranty period:

1.1 Transparency

The UV protected surface retains its transparency. The loss of the light transmission level on the entire panel width is not more than 8 % (eight percent) after expiry of 10 years after delivery according to ASTM D 1003 standard (measured by the average value over the entire panel width) in comparison to the original sample.

1.2 Yellowing Resistance

The yellowing factor, measured by the industrial standard ASTM D 1925, shall not change in the course of ten years after delivery of the LBE / MFP / U-Panels by more than 10 Delta (measured by the average value over the entire panel width) in comparison to the original sample. The optical properties under 1.1 and 1.2 are only to be measured with cleaned and scratch-free panels over the entire panel width.

1.3 Breakage Resistance

During the term of the warranty, hail shall not cause breakage. Breakage by hail within the meaning of this provision shall exist if, with a simulated hail test of 20 mm thick artificial hailstones are shot into the UV protected elementary surface at a speed of 21 m/sec and the surface is penetrated thereby. In case of breakage due to hail, RODECA can have the justification for the complaint examined by a simulated hail test undertaken on a non-damaged panel.

2.0 Warranty Period

The warranty period begins upon the delivery of the LBE / MFP / U-Panels and is for 10 years.

3.0 Substitute Replacement Materials

The warranty obligation of RODECA in terms of scope is limited as follows:

In cases of a justified complaint, RODECA can, at its option, provide substitute replacement materials ex works or reimburse the purchaser the purchase price according to the following provisions.

RODECA shall grant with transparency/yellowing		with breakage
up to 5th year	100 % Replacement/reimbursement	100 % Replacement/reimbursement
in the 6th year	75 % Replacement/reimbursement	50 % Replacement/reimbursement
in the 7th year	60 % Replacement/reimbursement	40 % Replacement/reimbursement
in the 8th year	45 % Replacement/reimbursement	30 % Replacement/reimbursement
in the 9th year	30 % Replacement/reimbursement	20 % Replacement/reimbursement
in the 10th year	15 % Replacement/reimbursement	10 % Replacement/reimbursement

4.0 Validity

The manufacturer's warranty shall apply for installation of the goods inside Europe.

5.0 Warranty Preconditions

5.1 This manufacturer's warranty shall only be valid if the following conditions exist cumulatively:

- 5.1.1 the goods have been paid for;
- 5.1.2 the purchaser examines the goods without undue delay after receipt and immediately gives notice of any defects;
- 5.1.3 the purchaser gives written notice of the defect within one week of the determination thereof with presentation of the invoice;
- 5.1.4 the purchaser makes an inspection by RODECA possible;
- 5.1.5 the warranty object objected to was stored, transported, processed and laid in accordance with the technical information announced by RODECA and in accordance with the DIN standards applicable at the date of the delivery;
- 5.1.6 the assembly and servicing guidelines of RODECA have been complied with;
- 5.1.7 The LBE / MFP / U-Panels may only be exposed to the normal interior and exterior temperatures (the Delta between internal and external temperature does not exceed 50°C) but may not, however, be brought in contact with other heat sources.
- 5.1.8 The LBE / MFP / U-Panels have not been thermally shaped and have not been used there where the influence of wind and fine sand can cause damage or deterioration to the elements and by which the technical or aesthetic properties of the elements can be influenced.
- 5.1.9 The light transmission value of the LBE / MFP / U-Panels is higher than 40% and sufficient ventilation is considered.

6.0 Exemption from Liability

The warranty is precluded if the defect has occurred as a consequence of acts of violence, unqualified interferences or force majeure with the exception of hail. An unqualified interference exists, in particular, if the following provisions are not observed:

- 6.1 The LBE / MFP / U-Panels must be protected against disadvantageous effects of chemicals.
- 6.2 With the application of the elements, no scratches and dents may occur.
- 6.3 The LBE / MFP / U-Panels may not be installed with equipment other than RODECA System equipment.
- 6.4 No unsuitable connection, fastening and sealing elements may be used.
- 6.5 Neither non-contractual adhesives nor non-contractual sealants may be applied.
- 6.6 The LBE / MFP / U-Panels may be exposed to weather only with the UV protected surface.
- 6.7 The permissible cold bending radius is dependent upon the panel and may not fall below this value (cf. product data sheets).

7.0 Replacement Performance

Should a replacement performance occur pursuant to § 3 of this Warranty, claims of the purchaser from this warranty with regard to the delivered replacement material shall exist only within the warranty period still remaining at the date of the replacement delivery. The notification of damage shall not inhibit or interrupt the running of the warranty period.

8.0 Miscellaneous

- 8.1 The law of the FRG shall apply for all legal relationships of the Parties from the warranty agreement.
- 8.2 The warranty terms 05/2010 shall apply for all contracts as of May 2010 and substitute all former warranty terms.
- 8.3 Jurisdiction for all claims from the warranty is Mülheim an der Ruhr, FRG.



10- years warranty LBE / MFP / U-Panels longlife plus

Stand: 10/10

The limited warranty assumed by RODECA vis-à-vis the purchaser shall be in effect in addition to the statutory liability for defects of the seller which shall remain completely unaffected thereby.

1.0 Subject Matter of the Warranty

RODECA warrants to the purchaser that the panels manufactured by RODECA (LBE / MFP / U-Panels) of the type "longlife plus" and as from the thickness of 16 mm and as from 2,40 kg/m² (Subject Matter of the Warranty) shall possess the following properties during the warranty period:

1.1 Transparency

The UV protected surface retains its transparency. The loss of the light transmission level on the entire panel width is not more than 8 % (eight percent) after expiry of 10 years after delivery according to ASTM D 1003 standard (measured by the average value over the entire panel width) in comparison to the original sample.

1.2 Yellowing Resistance

The yellowing factor, measured by the industrial standard ASTM D 1925, shall not change in the course of ten years after delivery of the LBE / MFP / U-Panels by more than 10 Delta (measured by the average value over the entire panel width) in comparison to the original sample. The optical properties under 1.1 and 1.2 are only to be measured with cleaned and scratch-free panels over the entire panel width.

1.3 Breakage Resistance

During the term of the warranty, hail shall not cause breakage. Breakage by hail within the meaning of this provision shall exist if, with a simulated hail test of 20 mm thick artificial hailstones are shot into the UV protected elementary surface at a speed of 21 m/sec and the surface is penetrated thereby. In case of breakage due to hail, RODECA can have the justification for the complaint examined by a simulated hail test undertaken on a non-damaged panel.

2.0 Warranty Period

The warranty period begins upon the delivery of the LBE / MFP / U-Panels and is for 10 years.

3.0 Substitute Replacement Materials

The warranty obligation of RODECA in terms of scope is limited as follows:

In cases of a justified complaint, RODECA can, at its option, provide substitute replacement materials ex works or reimburse the purchaser the purchase price according to the following provisions.

	with transparency/yellowing	with breakage
up to 7th year	100 % Replacement/reimbursement	100 % Replacement/reimbursement
in the 8th year	70 % Replacement/reimbursement	50 % Replacement/reimbursement
in the 9th year	60 % Replacement/reimbursement	40 % Replacement/reimbursement
in the 10th year	50 % Replacement/reimbursement	30 % Replacement/reimbursement

4.0 Validity

The manufacturer's warranty shall apply for installation of the goods inside Europe.

5.0 Warranty Preconditions

5.1 This manufacturer's warranty shall only be valid if the following conditions exist cumulatively:

- 5.1.1 the goods have been paid for;
- 5.1.2 the purchaser examines the goods without undue delay after receipt and immediately gives notice of any defects;
- 5.1.3 the purchaser gives written notice of the defect within one week of the determination thereof with presentation of the invoice;
- 5.1.4 the purchaser makes an inspection by RODECA possible;
- 5.1.5 the warranty object objected to was stored, transported, processed and laid in accordance with the technical information announced by RODECA and in accordance with the DIN standards applicable at the date of the delivery;
- 5.1.6 the assembly and servicing guidelines of RODECA have been complied with;
- 5.1.7 The LBE / MFP / U-Panels may only be exposed to the normal interior and exterior temperatures (the Delta between internal and external temperature does not exceed 50°C) but may not, however, be brought in contact with other heat sources.
- 5.1.8 The LBE / MFP / U-Panels have not been thermally shaped and have not been used there where the influence of wind and fine sand can cause damage or deterioration to the elements and by which the technical or aesthetic properties of the elements can be influenced.
- 5.1.9 The light transmission value of the LBE / MFP / U-Panels is higher than 40% and sufficient ventilation is considered.

6.0 Exemption from Liability

The warranty is precluded if the defect has occurred as a consequence of acts of violence, unqualified interferences or force majeure with the exception of hail. An unqualified interference exists, in particular, if the following provisions are not observed:

- 6.1 The LBE / MFP / U-Panels must be protected against disadvantageous effects of chemicals.
- 6.2 With the application of the elements, no scratches and dents may occur.
- 6.3 The LBE / MFP / U-Panels may not be installed with equipment other than RODECA System equipment.
- 6.4 No unsuitable connection, fastening and sealing elements may be used.
- 6.5 Neither non-contractual adhesives nor non-contractual sealants may be applied.
- 6.6 The LBE / MFP / U-Panels may be exposed to weather only with the UV protected surface.
- 6.7 The permissible cold bending radius is dependent upon the panel and may not fall below this value (cf. product data sheets).

7.0 Replacement Performance

Should a replacement performance occur pursuant to § 3 of this Warranty, claims of the purchaser from this warranty with regard to the delivered replacement material shall exist only within the warranty period still remaining at the date of the replacement delivery. The notification of damage shall not inhibit or interrupt the running of the warranty period.

8.0 Miscellaneous

- 8.1 The law of the FRG shall apply for all legal relationships of the Parties from the warranty agreement.
- 8.2 The warranty terms 05/2010 shall apply for all contracts as of May 2010 and substitute all former warranty terms.
- 8.3 Jurisdiction for all claims from the warranty is Mülheim an der Ruhr, FRG.



Unfold your creativity plan with us!

The new generation of multi-wall polycarbonate elements



The RODECA principle

Simpler design

The proven geometry of the translucent building elements and optimized fasteners essentially increase the load capacities of panels. Furthermore premium quality frame and window systems for facade and roof applications have been developed to make the system universally applicable.

Translucent heat insulation

ISOCLEAR Series with a U-Value of 1.0 W/m²K - 3.0 W/m²K (depending on the type of installation) defines new standards in thermal insulation for the facades and roof glazing. The new heat insulation values established by the Thermal Regulation are achieved and even exceeded by the products of ISOCLEAR Series. In view of rising energy costs this is a decisive criterion in selecting appropriate glazing materials for energy-efficient buildings.

Other RODECA products:

- RODECA Translucent Building Elements
40 mm, 50 mm and 60 mm
- RODECA multi-wall sheets from 4 mm up to 50 mm
- RODECA Multi-Functional Panels
- RODECA U-Panels from Polycarbonate
- RODECA RT - Roof light systems
- RODECA Roof light systems for ISO-Panel for roof and facade application
- RODECA Windows for Roof and Façade
- RODECA Smoke and Heat Exhaust Vent Systems



RODECA GmbH
Freiherr-vom-Stein-Str. 165
45473 Mülheim an der Ruhr
Tel. +49 (0)208-76502-0
Fax +49 (0)208-76502-78
Mail info@rodeca.de

www.rodeca.de

**So when do you start
planning with us?**